



# KARI Float Switch Operation *Manual*



## **Alarm**

Liquid rises to  
a level for monitoring.



Image 1H shows the operation  
of the KARI Float Switch

# KARI Float Switch

## – compact and reliable

The KARI Float Switch is a control device for charging and discharging pumps and motor and magnetic valves. It is also an alarm device that alerts the user at specified surface levels. Thanks to its large float casing (Ø 170 mm), the KARI Float Switch has a buoyancy that guarantees smooth, trouble-free operation under all conditions. SGS FIMKO Oy (the Finnish Electrical Inspectorate) has performed testing in accordance with the Low Voltage Directive (LVD) and approved the KARI Float Switch for use in non-flammable liquids at 250 volts.

### FUNCTIONS

1C	Change-over switch.
1H	High level alarm.
1L	Low level alarm.

### ORDER CODE

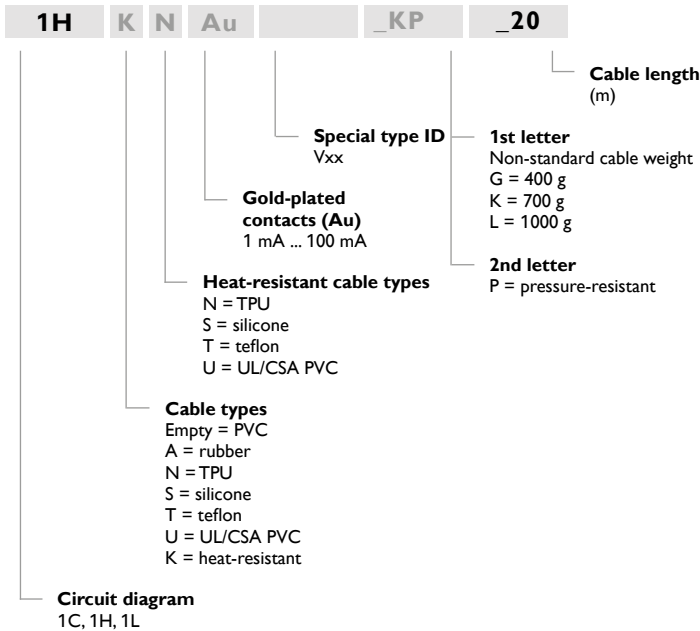

# CIRCUIT DIAGRAM

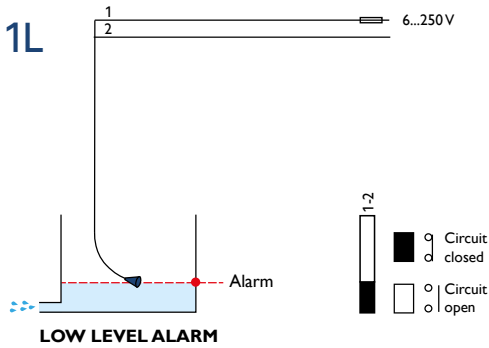
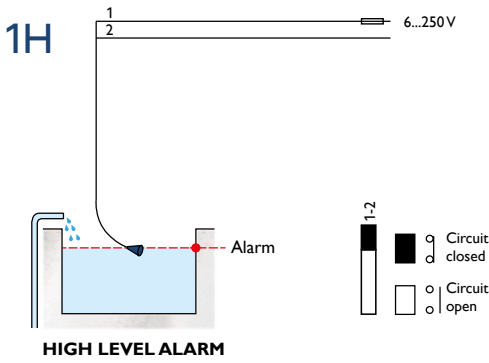
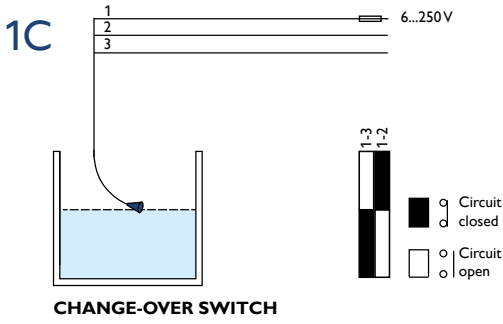

# TECHNICAL INFORMATION

Switching element	Microswitch
Voltage	6 ... 250V AC
Max. rated current	6A res., 3A ind.
Rated current with gold-plated contacts	1 mA ... 100 mA
Maximum DC power	75 VA (=0,3A, 250V)
Pressure rating for special types	200 kPa
Max. operating temperature	+55 °C (+75 °C supplied to order)
Cable length	5 m (other lengths supplied to order)
Weight of 5 m cable	1,2 kg
Largest diameter	170 mm
Length of float casing	155 mm
Buoyancy in water	6 N
Float material	Polypropylene (PP)
Cable insulation (standard)	PVC
Other cable options	Rubber, TPU, teflon, silicone
Water-tightness	IP 67

## DIMENSIONS

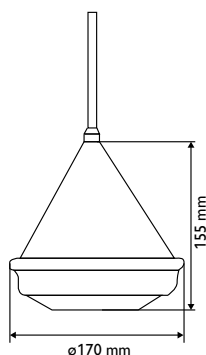

### A QUALITY FINNISH PRODUCT

Our quality control is based on the ISO 9001 quality management system. Each product is subject to a full operation test. The KARI Float Switch is also available in versions which fulfills the U.S. and Canadian national safety standards.



ROHS

# INSTALLATION AND ADJUSTMENT

The KARI Float Switch is mounted to hang from its cable. The float switch floats on the surface of the liquid and follows the movement of the liquid's surface. Connection occurs when the float tilts. The height of the alarm level is determined by the height at which the float hangs.

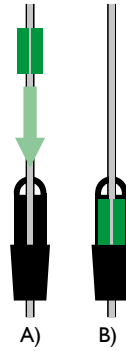

Image 1. Cable weights and the hanging loop are fixed to the cable with a clamp wedge (A-B).

## Installation considerations

- The only adjustable element is the height at which the float hangs. Fine tuning must be carried out on the basis of the applicable object and the conditions.
- If the viscosity of the liquid is particularly high or floating to the sides needs to be restricted, we recommend using a cable weight. Weights delivered as accessories are fixed to the cable with a clamp wedge (see Image 1).
- It is important to keep the junction box in a dry environment. If this is not possible, the ends of float switch cables must be covered with, for example, protective grease (see Images 2 and 3). An IP68 junction box is also available.
- The installation site must be selected such that the float cannot become caught under or stay on top of any surface or get entangled in other structures (see Image 4).
- When the float switch is tested without being floated, its correct orientation must be considered: the 'UP' mark on the side of the bottom portion must face upward. For example, when placed on the floor on its side, the float switch settles into this position because of its internal keel weight (see Image 5).
- Tying the float switch from its cable near the float to, for example, the ascension pipe of the pump decreases the useful life of the cable; the float switch should hang freely from its cable (as shown in Image 6).

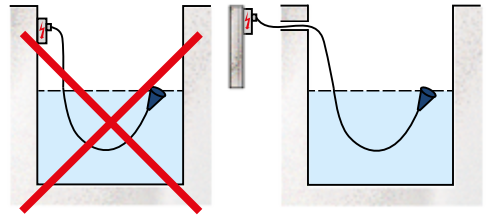

Image 2. Avoid extending or connecting the cable in humid conditions.

Image 3.

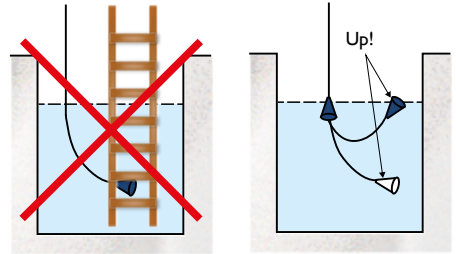

Image 4. Take care to ensure the free movement of the float.

Image 5. Note the correct orientation of the float.

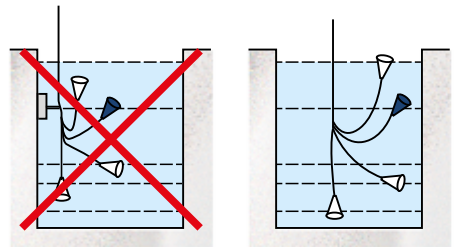

Image 6. Avoid fixing the float such that a sharp corner can cause kinks or wear to the cable.



Kari-Finn Oy  
Koneharjunkatu 1  
FI-15850 LAHTI  
Tel. +358 3 876 810  
info@kari.fi  
www.kari.fi



## Over 50 years of experience in product development

Kari-Finn Oy developed its first float switch back in 1965. Since then, we have designed, tested, and manufactured millions of float switches, for a wide variety of operating environments. Thanks to our research work and feedback from customers, we have been very successful in developing our product line.

## International success in innovation and export since 1977

It was several decades ago, in 1977, when the KARI Float Switch was awarded a gold medal at the Brussels International Exhibition of Invention and a medal of the City of Brussels for an extensively exported product. At that time, exports covered all countries in Europe, the United States, South Africa, and Japan. Later on, exports reached every continent.

